

# Head-Capacity Envelope

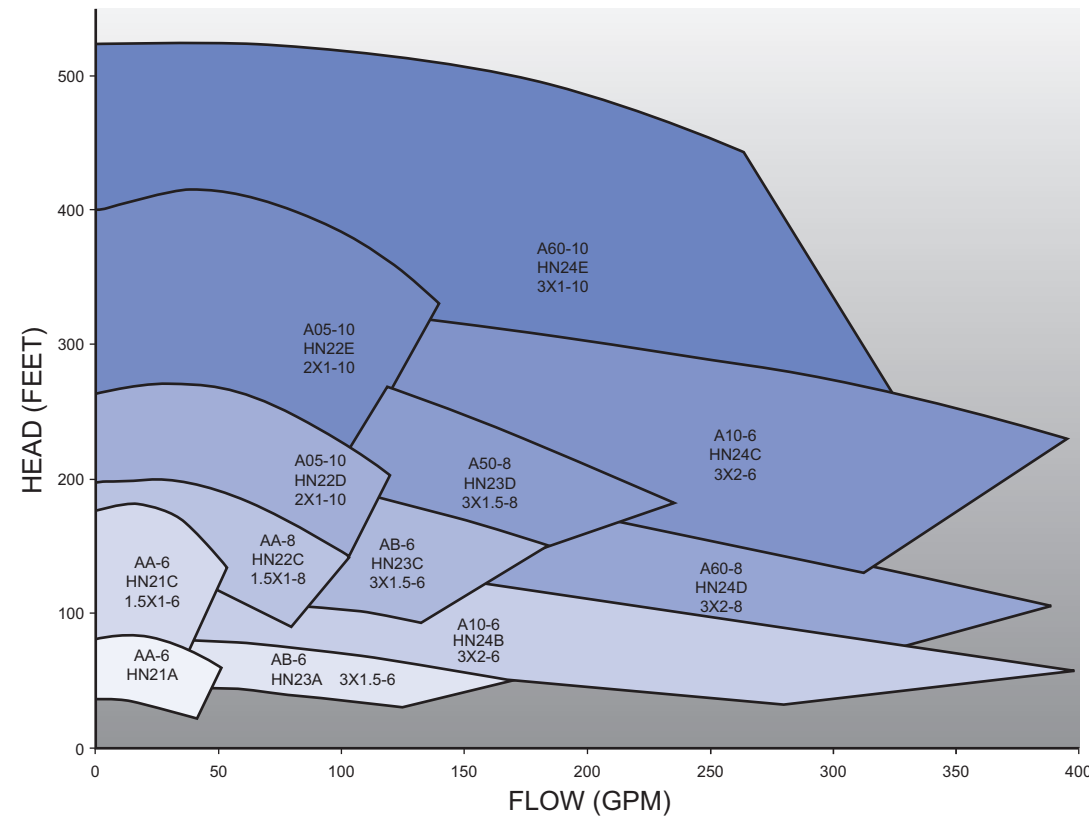

# NIKKISO NON-SEAL<sup>®</sup> CANNED MOTOR ANSI PUMP

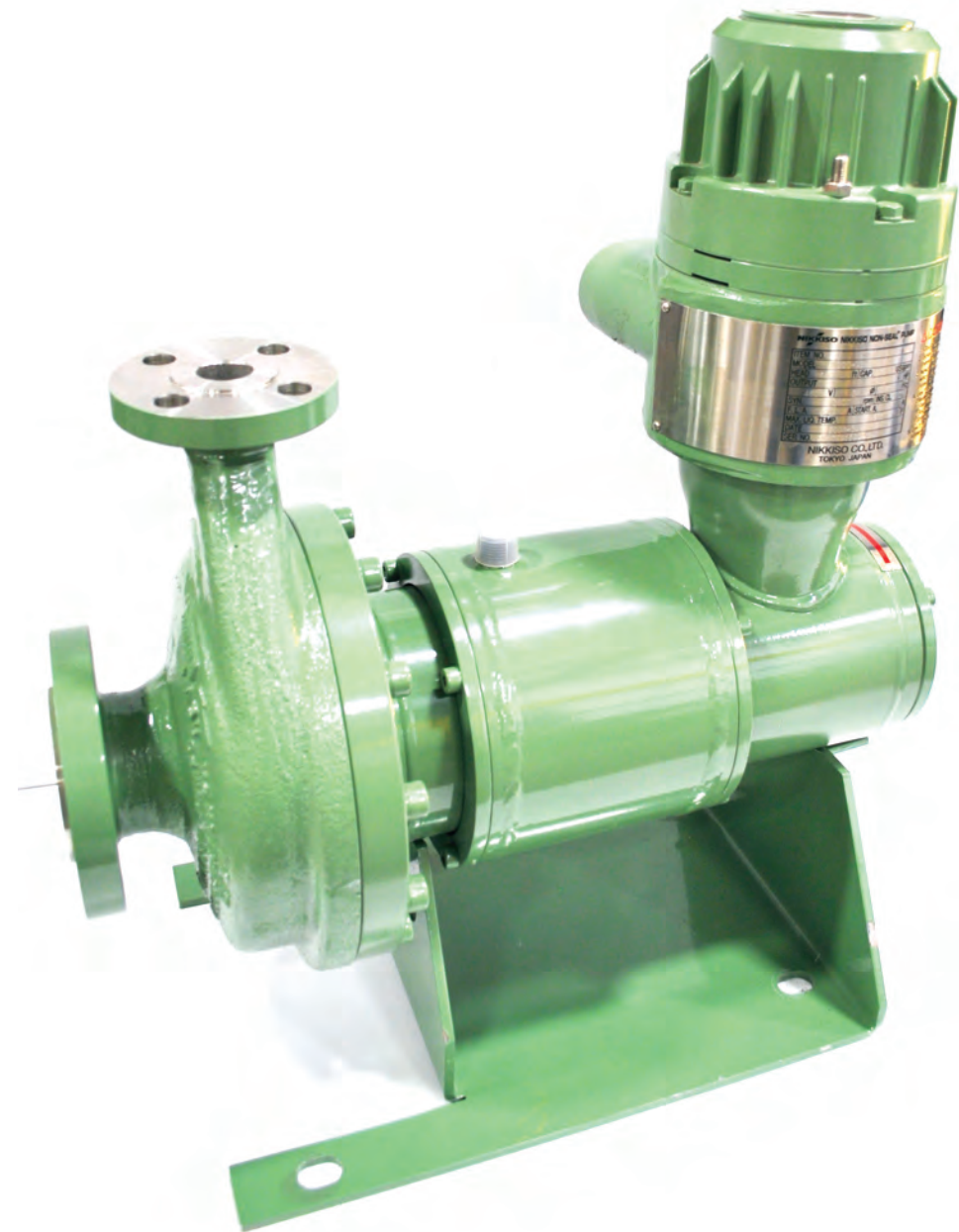

# Pump Dimensions

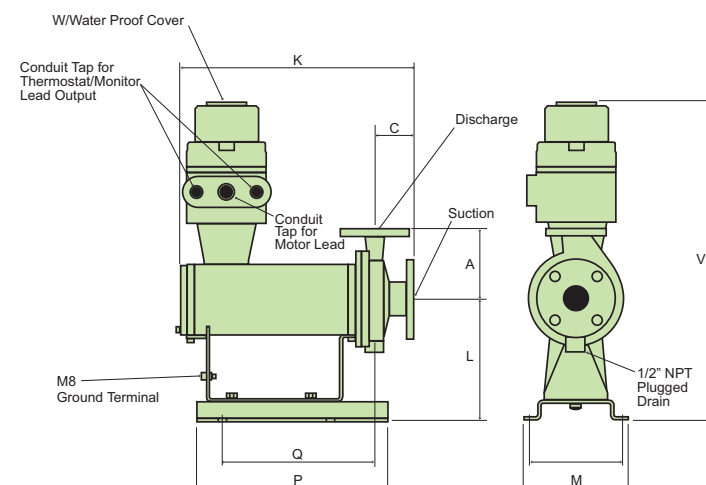

ANSI #	Pump Model	NOMINAL FLANGE SIZE									
		A	C	K	L	M	P	Q	V	SUCTION	DISCHARGE
AA-6	HN21A-A3	6.50	4.00	19.83	5.25	7.50	15.54	7.25	20.33	1.5	1
AA-6	HN21C-A3	6.50	4.00	19.83	5.25	7.50	15.54	7.25	20.33	1.5	1
AA-8	HN22C-A3	6.50	4.00	19.87	5.25	7.50	15.58	7.25	20.33	1.5	1
AA-8	HN22C-B3	6.50	4.00	25.18	5.25	7.50	22.59	7.25	21.11	1.5	1
A05-10	HN22D-A3	8.50	4.00	20.22	8.25	11.25	15.94	12.50	23.33	2	1
A05-10	HN22D-B3	8.50	4.00	25.53	8.25	11.25	22.94	12.50	24.11	2	1
A05-10	HN22E-C2	8.50	4.00	28.80	8.25	11.25	26.18	12.50	27.46	2	1
AB-6	HN23A-A3	8.50	4.00	20.58	5.25	7.50	16.29	7.25	20.33	3	1.5
AB-6	HN23C-A3	8.50	4.00	20.30	8.25	11.25	16.02	12.50	20.33	3	1.5
AB-6	HN23C-B3	8.50	4.00	25.61	8.25	11.25	23.02	12.50	21.11	3	1.5
A50-8	HN23D-B3	8.50	4.00	25.69	8.25	11.25	23.10	12.50	24.11	3	1.5
A50-8	HN23D-C4	8.50	4.00	31.83	8.25	11.25	29.21	12.50	27.46	3	1.5
A10-6	HN24B-A3	8.25	4.00	21.01	8.25	11.25	16.72	12.50	23.33	3	2
A10-6	HN24B-B3	8.25	4.00	26.32	8.25	11.25	23.73	12.50	24.11	3	2
A10-6	HN24C-B3	8.25	4.00	26.32	8.25	11.25	23.73	12.50	24.11	3	2
A10-6	HN24C-C4	8.25	4.00	32.46	8.25	11.25	29.84	12.50	27.46	3	2
A60-8	HN24D-B3	9.50	4.00	26.28	8.25	11.25	23.69	12.50	24.11	3	2
A60-8	HN24D-C4	9.50	4.00	32.42	8.25	11.25	29.80	12.50	27.46	3	2
A60-10	HN24E-C4	9.50	4.00	32.97	8.25	11.25	30.35	12.50	27.46	3	2
A60-10	HN24E-D2	9.50	4.00	33.88	8.25	11.25	31.01	12.50	27.46	3	2



# NIKKISO Pumps America, Inc.

3433 N Sam Houston Pkwy W, #400 • Houston, TX 77086 • Phone: 281-310-6747 • www.nikkisopumpsamerica.com

# NIKKISO Pumps America, Inc.

# ANSI Drop In Replacement

NIKKISO NON-Seal® Canned Motor ANSI pumps are the ideal replacement candidates for existing Mechanically sealed and Magnetically driven ANSI Pumps

## Key Benefits

- Replaces existing ANSI Pumps
- No piping or foundation modifications required
- No seals to fail or maintain - TRUE ZERO EMISSIONS
- True secondary containment eliminates the possibility of product leakage
- No Motor/Pump/Coupling alignment
- No Impeller adjustments or shims
- Unique E-Monitor alerts you of pump and bearing status
- Corrosion resistant 316ss construction
- ANSI 150# Flanges
- Greater MTBR (Mean Time Between Repair)
- Easy to maintain
- Simple design equals enhanced reliability
- Quick Delivery from our warehouse in Houston, Tx
- 311 degF Temperature Limit
- 300 psig @ 311 DegF Pressure Limit



We stock pumps at our Houston, Texas office for quick delivery.

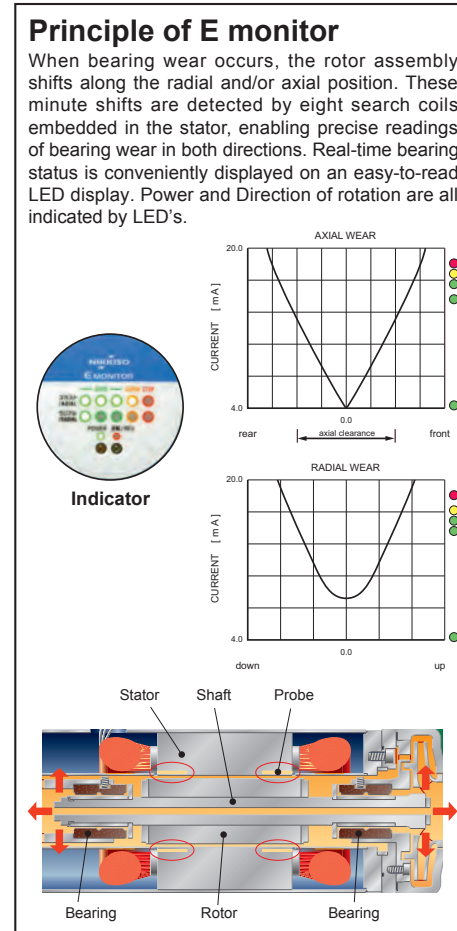

# Model HN with Electric Bearing Monitor

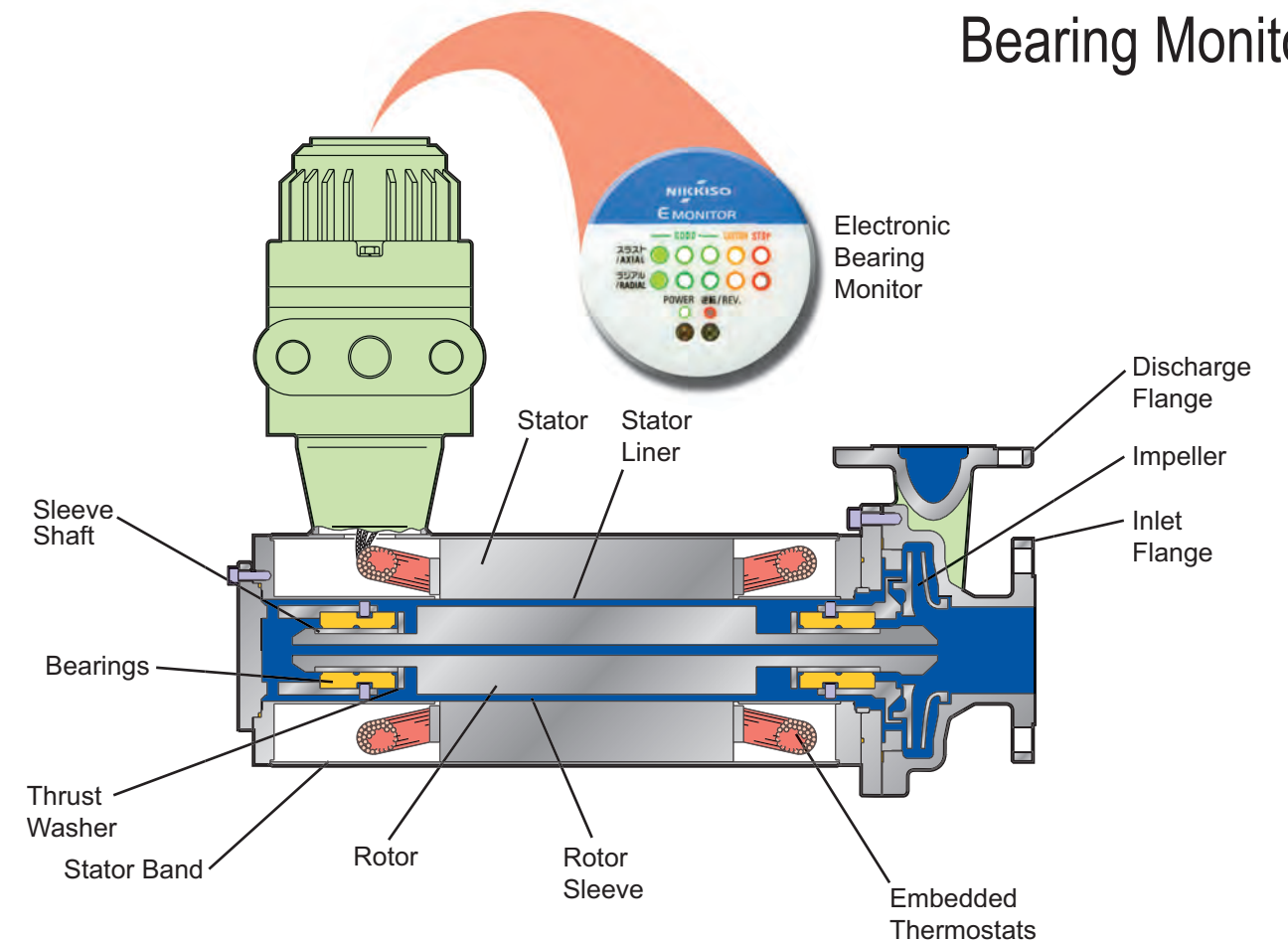

# Other Types of ANSI Pumps

# Building Block System

Nikkiso applies the building block system to all of their canned motor pumps. Wide interchangeabilities of pump modules and motor modules are available and these modules can be freely combined, so it is possible to minimize numbers of spare pumps, motors and numbers of parts in stock. This also makes on site repair possible.

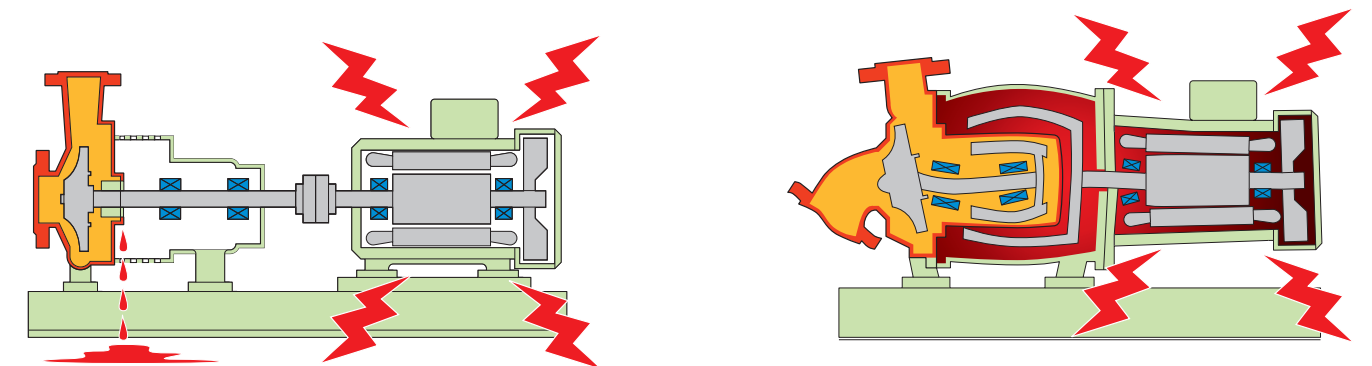
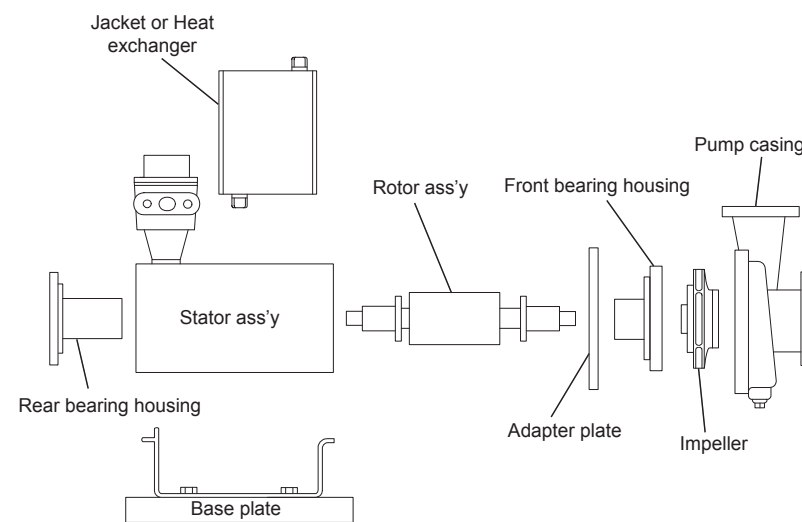

## Conventional Centrifugal Pumps with Double Mechanical Seals

- Environment pollution or fire in chemical plants is caused by liquid leakage from mechanical seals.
- Large space is required for installation.
- Flushing is required.
- Noise generated from coupling and motor fan.
- Increase maintenance costs for changing mechanical seals.
- Daily checking ----- leakage from mechanical seals and making-up lubricant.

## Magnetic Drive Pumps

- No secondary leak containment.
- No effective way to control bearing fluid environment ----- sensitive to solids and vaporization.
- No way to monitor wear of impeller shaft bearings. Coupling misalignment leads to input bearing failure and rubbing of containment shell.
- Noise generated from coupling and motor fan.
- Efficiency significantly drops in high temperature application.
- Not suitable for high pressure design.